



Guidelines on Interconnection with Transmission Pipelines

Date issued: November 2009





About Gas Industry Co.

Gas Industry Co was formed to be the co-regulator under the Gas Act.

As such, its role is to:

- recommend arrangements, including rules and regulations where appropriate, which improve:
 - the operation of gas markets;
 - access to infrastructure; and
 - consumer outcomes;
- administer, oversee compliance with, and review such arrangements; and
- report regularly to the Minister of Energy on the performance and present state of the New Zealand gas industry, and the achievement of Government's policy objectives for the gas sector.

Authorship

This paper was prepared by Ian Wilson

Contents

1	Introduction	1
2	Glossary and Illustrated Terms	5
3	Service Description	9
4	Application Phase	13
5	Planning Phase	17
6	Contract Negotiation Phase	20
7	Design Phase	29
8	Construction Phase	35
	Appendix A Documentation	39

1

Introduction

1.1 Context

The Gas Act 1992 (Act) and the April 2008 Government Policy Statement on Gas Governance (GPS) provide for the development of arrangements that provide access to gas transmission pipelines on reasonable terms and conditions. The ability for parties such as gas producers, network owners or end-users to physically interconnect with pipelines is an intrinsic element of such access.

Gas Industry Co's 2006 review of transmission access issues identified a number of concerns relating to interconnection with transmission pipelines. Subsequent discussions between Gas Industry Co and interconnecting parties suggest that:

- interconnection processes are poorly defined, so that parties seeking interconnection are exposed to a substantial degree of uncertainty over project timing, and key decision points;
- technical requirements for interconnection equipment have been changed during the course of projects, causing uncertainty, delay and additional cost;
- roles and responsibilities have been confusing, in part because it is unclear when personnel are acting in the role of transmission system owner, contractor or technical operator; and
- liability/insurance matters have not been addressed until late in the process.

As the industry body under the Act, Gas Industry Co may recommend the introduction of rules or regulations to address these concerns, and achieve the objectives of the Act and GPS. However, Gas Industry Co considers that it is helpful to first develop guidelines that set out principles, procedures, documentation requirements, and arrangements for addressing disputes. These Guidelines represent Gas Industry Co's view on the features of good interconnection processes. It is hoped that the Guidelines will assist the industry to improve interconnection processes, without the need for further Gas Industry Co review, or possible regulatory intervention.

Gas Industry Co will monitor the effectiveness of these Guidelines in meeting the Act and GPS objectives. If it is not satisfied with the degree of voluntary compliance, it may consider other options, including recommending rules or regulations to the Minister.

1.2 Current Arrangements

Open access to gas transmission pipelines in New Zealand began in the mid-1990s when Natural Gas Corporation (now Vector) introduced an open access regime for its transmission system. In 2005 the Maui pipeline, owned by the Maui Mining Companies¹ and managed by Maui Development Limited (MDL), also introduced an open access regime. The Maui pipeline had previously been used exclusively for the transport of Maui gas.

Open access effectively allows any party meeting the prudential requirements of a transmission system owner (TSO) to have gas transported through the system on posted terms and conditions. However, it may be necessary to first construct new interconnection stations where the party wishes to inject and/or withdraw gas from the transmission pipeline.

Section 2.12 of MPOC provides that MDL shall allow any person to connect to its pipeline if they demonstrate an ability to meet the requirements of MPOC, ensure there is no interference with the safe operation of the pipeline and indemnify MDL for loss arising from the installation of a new Welded Point. There is no such provision in the Vector Transmission Code (VTC). The VTC mainly relates to the relationship between Vector and parties transporting gas through its pipelines (its 'shippers', and not to the relationship between Vector and parties who own, or wish to develop, facilities that interconnect with Vector's pipelines. However, as with the Maui pipeline, interconnecting parties must satisfy minimum standards set by Vector. If a pipeline owner was to take advantage of its market power to unreasonably prevent access to its pipeline, the Commerce Act 1986 allows access seekers or the Commerce Commission to bring an action against it.

There have been several new interconnections to the transmission network since open access began. The Maui Pipeline Operating Code (MPOC) already included technical requirements for any new welded point², and general requirements for any new party wishing to interconnect. MDL also publishes procedures for interconnection to the Maui pipeline. Vector similarly provides parties seeking interconnection (IPs) with its technical requirements and standard agreements. However, the new interconnections provided opportunities for the TSOs to refine their technical requirements and develop more detailed interconnection processes.

While both Vector and MDL have improved their interconnection processes, Gas Industry Co is concerned that some problems arising from recent interconnections to both the Maui and Vector

¹ The companies with interests in the Maui Mining Companies Joint Venture are Shell (83.75%), OMV (10%) and Todd (6.25%).

² 'Welded Point' is the term used in the MPOC to refer to the point of connection between the Maui Pipeline and the infrastructure of an interconnected party.

pipelines might require further attention. These include unscheduled delays, confusion over roles, perceived financial barriers, and frustration that complaints are unresolved.

1.3 Purpose

Gas Industry Co considers that these Guidelines provide principles, procedures, and documentation requirements of a standard suitable for a TSO to develop its interconnection arrangements. Dispute resolution procedures are also proposed.

The objectives of the Guidelines are to:

- describe what a TSO's interconnection policy should address;
- describe the phases of interconnection, what should happen in each phase, and the key decision points;
- establish principles that should apply to the overall provision of an interconnection service, and to each phase of interconnection;
- encourage TSOs to adopt consistent interconnection documentation;
- establish clear responsibilities; and
- minimise barriers to entry by promoting transparency and efficiency.

1.4 Scope of Guidelines

The Guidelines first describe the information a TSO should make available about its interconnection service – see Chapter 3 Service Description. The Guidelines then address each phase of the interconnection process:

- the Application Phase – see Chapter 4 – to the point where the TSO advises the IP it accepts the application;
- the Planning Phase – see Chapter 5 – which allots to the TSO and IP responsibilities for the ownership, design and construction of assets;
- the Contract Negotiation Phase – see Chapter 6 – where the TSO and IP settle the terms of the Interconnection Establishment Agreement (ICEA), if required, and Interconnection Agreement (ICA);

- the Detailed Design Phase – see Chapter 7 - to the point where the TSO and Certifying Authority approve the design; and
- the Construction Phase – see Chapter 8 – to the point where the TSO approves the commissioning results and the station is available to ‘go live’.

These phases are not necessarily strictly sequential, and some overlap of the phases should be expected. For example the Contract Negotiation phase is likely to overlap the Design phase because aspects of the design affect the operation of the station.

These Guidelines do not address the operation of the station. It is expected that the ICA addresses all aspects of the station operation.

The Guidelines are relevant to all interconnections between a TSO’s assets and the assets of another party. These interconnections include receipt and delivery points and interconnections between transmission pipelines.

Capacity requirements are relevant to the design of interconnection metering and pressure control equipment and safety studies. However, the Guidelines do not address the provision of capacity for transporting gas between interconnection points³.

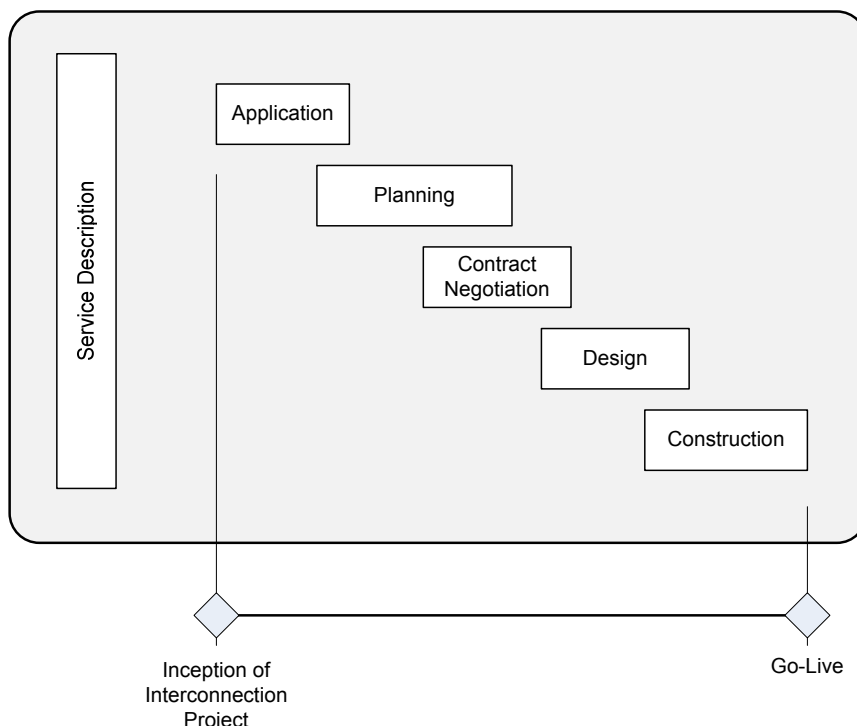

Figure 1 - Scope of Guidelines

³ Although it is accepted that at times it may be necessary to negotiate the ICA and TSA at the same time.

2

Glossary and Illustrated Terms

2.1 Glossary

Certifying Authority (CA)	The Certifying Authority (CA) recognised by the Secretary of Labour, in compliance with the HSE (Pipelines) Regulations 1999
delivery point	An interconnection point to a TSO's pipeline where gas is delivered from the pipeline
gas specification	NZS 5442 as amended or replaced from time to time
GPS	Government Policy Statement
ICA	Interconnection Agreement – an agreement between a TSO and an IP that addresses the commercial arrangements and operational requirements of the interconnection station
ICEA	Interconnection Establishment Agreement – an agreement between a TSO and an IP providing for the construction and commissioning of an interconnection station
interconnection	Establishing a physical connection between a TSO's transmission pipeline and the assets of another party
interconnection equipment	The physical equipment associated with the interconnection point, including the interconnection T (hot tap), metering, pressure control, filtration and odourisation equipment (where applicable) – refer to Figures 2 and 3
interconnection point	A point agreed between a TSO and IP where custody of gas (and responsibility for gas quality) is transferred
interconnection service	A TSO's offer of terms on which it will provide interconnection to its pipelines
interconnection station	A station containing some or all of the necessary pressure control, filtration, metering and odourisation equipment

IP	Interconnecting Party (IP) - the party seeking to interconnect with a transmission pipeline or already connected to a transmission pipeline. The IP may be: <ul style="list-style-type: none"> • the owner of an adjoining transmission system; • the owner of a production/treatment station; • the owner of a distribution system; or • the owner of a direct connect end user facility.
MPOC	Maui Pipeline Operating Code containing the multilateral terms of transportation and interconnection, which are referenced by relevant TSAs and ICAs
OATIS	Open Access Transmission Information System is the information system and internet site used to manage the day-to-day operations of open access on the Maui and Vector pipelines
odorisation standard	NZS 5263 as amended or replaced from time to time
receipt point	An interconnection point to a TSO's pipeline where gas is injected into the pipeline
RPO	Reasonable and Prudent Operator - a standard for performance of obligations equal to or better than good industry operating practice relative to recognised international practice
Rulings Panel	The person appointed as the Rulings Panel under regulation 61 of the Gas Governance (Compliance) Regulations 2008
System Operator	The agent(s) responsible for managing the forecasting and scheduling of gas flows, and data acquisition and title tracking on transmission pipelines, as appointed by the pipeline owner(s)
transmission services	The services provided by the TSO
TSA	Transmission Service Agreement - an agreement between a shipper and a TSO for the transportation of gas
TSO	Transmission System Owner
TSO specified assets	Equipment listed in section 3.4 which, regardless of ownership, will be designed, constructed, tested, operated and maintained according to the TSO's specifications
VTC	Vector Transmission Code – containing the multilateral terms of transportation which are referenced by relevant TSAs

2.2 Illustrated Terms

Receipt Point Interconnection Equipment

At receipt points, interconnection equipment includes all pipe work and equipment between the transmission pipeline and the interconnection station inlet. This includes the hot tap connection 'T',

and the interconnection station itself. In some situations, some or all of the parts of the interconnection station may be in the gas production/treatment plant. Some alternative configurations are illustrated below:

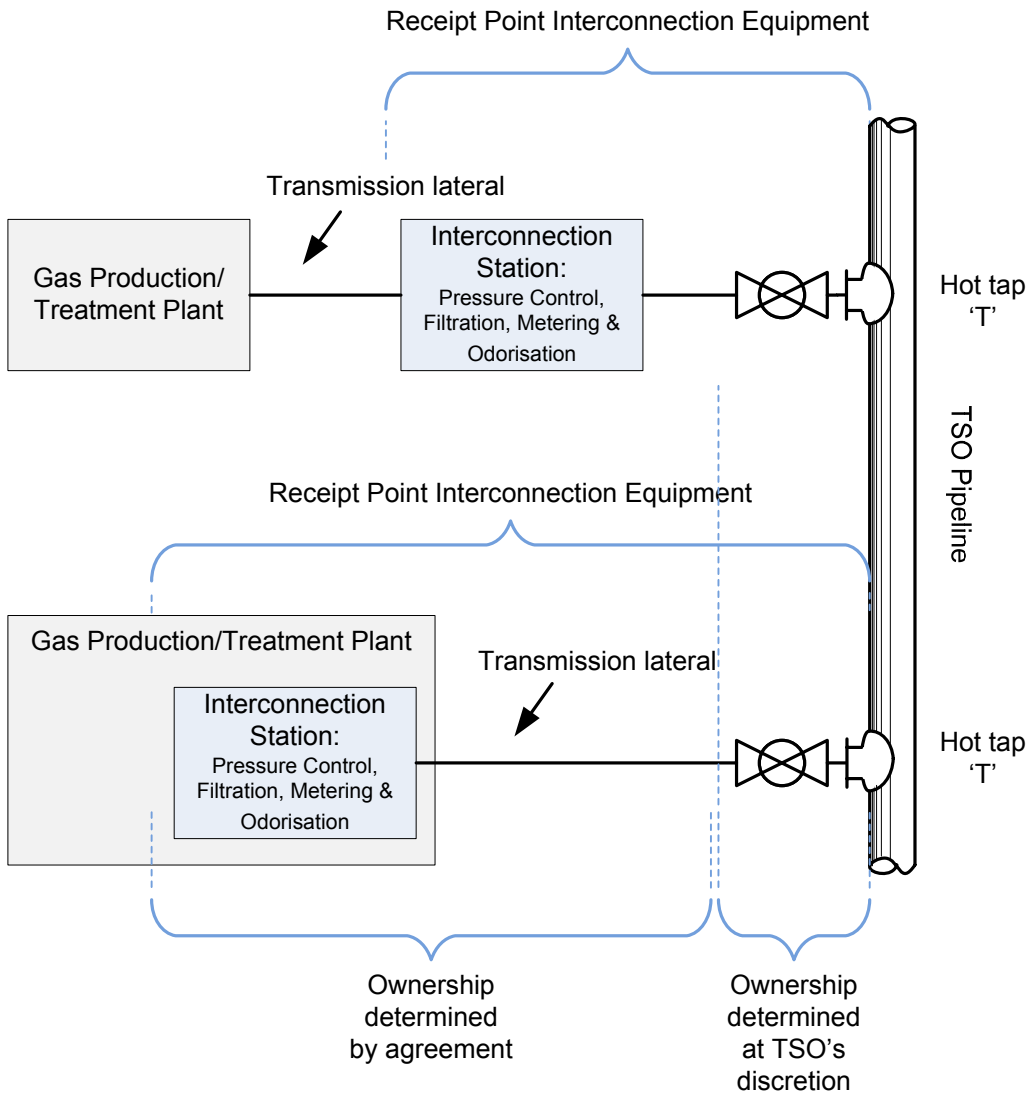

Figure 2 – Possible Receipt Point Interconnection Configurations

Delivery Point Interconnection Equipment

At delivery points, interconnection equipment includes all pipe work and equipment between the transmission pipeline and the consumer⁴/network interface, including the connection 'T', and the interconnection station itself.

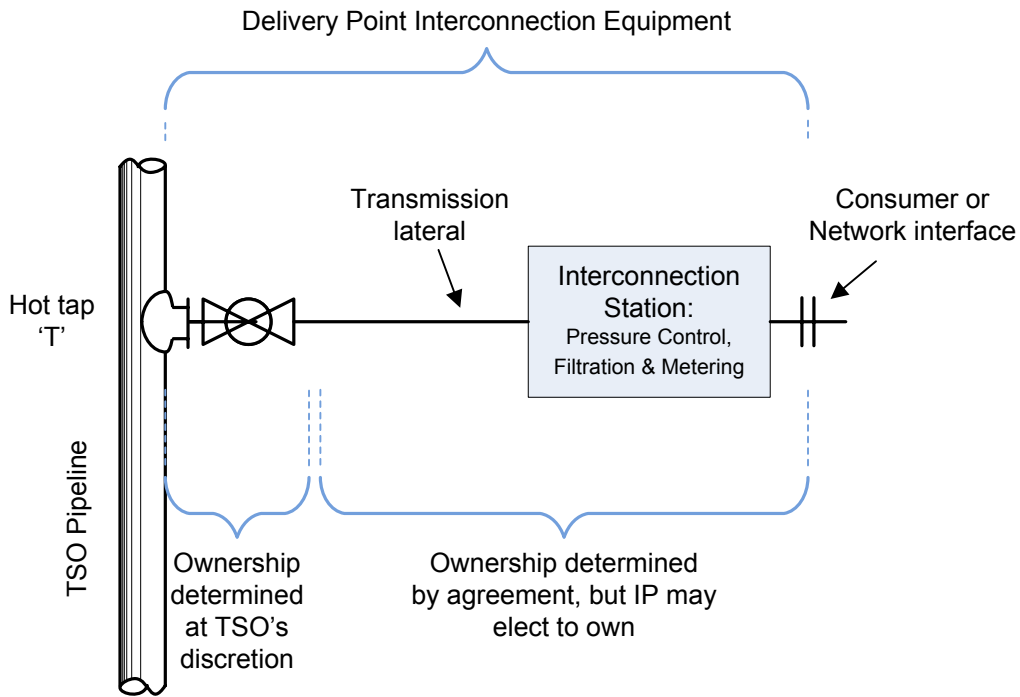

Figure 3 – Delivery Point Interconnection

⁴ Generally only applicable to large consumers.

3

Service Description

3.1 Principles

Throughout all phases of the interconnection process:

- The TSO and IP should:
 - seek to ensure that gas is ‘...delivered to existing and new customers in a safe, efficient, fair, reliable and environmentally sustainable manner’ (Gas Act, 43ZN(a));
 - negotiate and act in good faith;
 - negotiate and act in a timely manner;
 - provide reasonable access to personnel who are knowledgeable and, as far as is reasonably possible, authorised by their respective organisations to make decisions in respect of whatever aspect of the interconnection is being attended to⁵; and
 - advise the other party of the contact details of their representatives for technical and commercial matters and approvals.
- The TSO should:
 - process applications on a non-discriminatory basis, including applications of parties affiliated with the TSO;
 - make sufficient information available to the IP to enable it to assess the likely availability of transmission capacity to or from the interconnection point; and

⁵ It is accepted that certain matters, such as expenditures outside delegated authorities, may need to be referred to senior managers or boards.

- ensure that all equipment owned by the TSO complies with all relevant standards and regulations.
- The IP should:
 - where TSO specified assets are owned by the IP, ensure that those assets are designed, constructed, and operated according to the standards specified by the TSO; and
 - ensure that all equipment owned by the IP complies with all relevant standards and regulations.

3.2 Interconnection Policy

Each TSO should publish an interconnection policy that includes:

- a description of its access process from application through to operation of the new interconnection station;
- the information which an IP must provide at each stage of the interconnection process;
- links to all relevant standard contracts;
- the TSO's general policies relating to interconnection matters;
- links to any policies of the TSO which are relevant to a new interconnection;
- a description of any commercial prerequisites to approval of an interconnection application (for example, bonds or insurance);
- a description of the technical review principles and process used to assess an interconnection application; and
- a description of the dispute resolution arrangements that will apply to any matters related to interconnection not subject to the ICEA or ICA (which should have their own dispute resolution procedures). Recommended arrangements are set out in section 3.3 below.

See Appendix A for further detail of the recommended content of an interconnection policy.

3.3 Dispute Resolution

The Guidelines recommend that parties include a dispute resolution process as part of their interconnection arrangements. The proposed default option is for the same person who performs the Rulings Panel function under the Gas Act to resolve interconnection disputes. The process would be based on the Gas Governance (Compliance) Regulations 2008. Using this option will keep costs to a minimum and provide parties with access to a specialist tribunal.

3.4 Technical Standards

To recognise the TSO's risks as the pipeline owner and obligations as a reasonable and prudent operator, the TSO may specify the requirements for the following interconnection equipment:

- metering equipment, including gas analyser and all related instruments;
- SCADA equipment and interfaces;
- filtration and liquid removal systems;
- pressure control and protection equipment;
- odourisation equipment;
- interconnection 'T' (for example a hot tap) and isolation valve;
- electrical and cathodic protection isolation equipment; and
- other equipment specified in the Interconnection Policy.

These items are collectively referred to in these Guidelines as the 'TSO specified assets'.

In relation to technical standards, the TSO's requirements should be consistent with good operating practice and the relevant Standards and Codes of Practice. The requirements for TSO specified assets should cover the design, construction, commissioning, testing and operation of those assets.

The IP should be permitted to use alternative standards providing the IP demonstrates, to the TSO's reasonable satisfaction, that the standards meet or exceed the TSO's standards, and the alternative standards are acceptable to the Certifying Authority.

Where TSO owned assets are located within the IP's facilities, the design, construction, maintenance and operation of those assets should also comply with the standards specified by the IP in the ICEA and ICA.

3.5 Existing Interconnections

Some existing interconnection arrangements might not be covered by an ICA, or the ICA might not incorporate all the requirements of these Guidelines. In these cases, the interconnecting parties should establish an ICA or amend their existing ICA.

3.6 Pipeline Capacity

An ICA does not confer rights to transmission capacity and may be negotiated independently of transportation arrangements. In certain circumstances, the TSO may require the ICA and transportation arrangements to be negotiated together. This should not unnecessarily delay establishing an interconnection. The TSO's interconnection policy should discuss those circumstances.

4

Application Phase

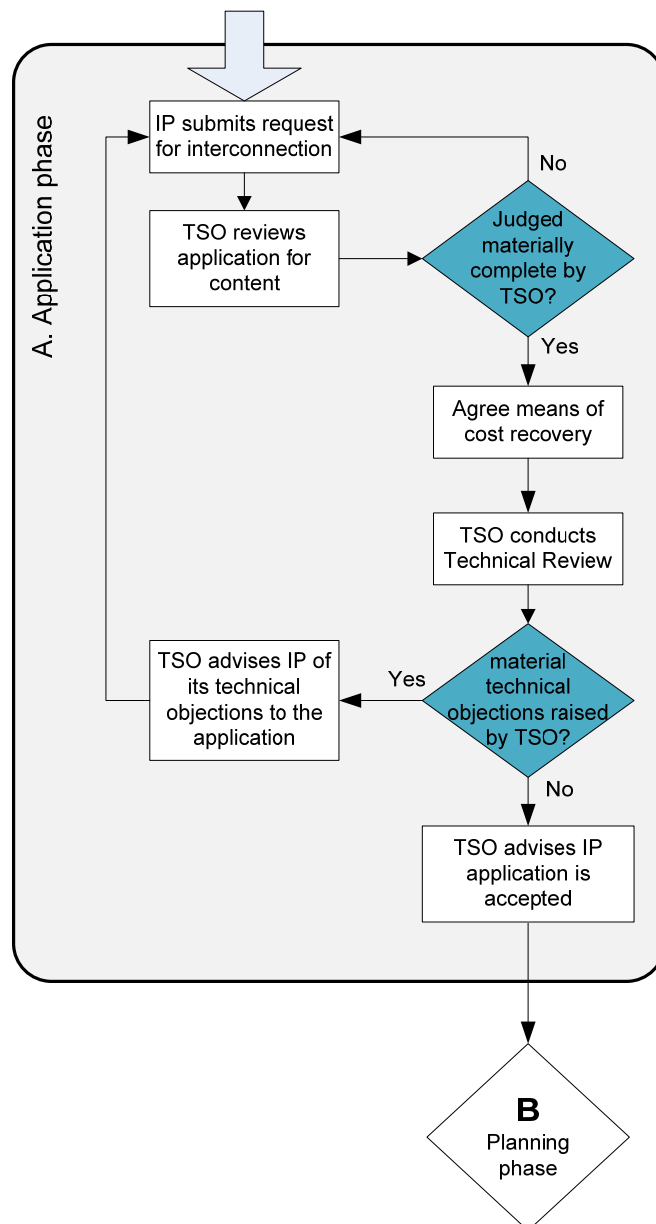

Figure 4 - Application Phase Process

4.1 Principles

The TSO:

- should provide the IP with:
 - an explanation of each phase of the interconnection process, and how an application for interconnection can be made; and
 - a full set of application documents, if not available for download;
- should carry out its technical review in line with the principles set out in its Interconnection Policy; and
- may recover the costs it incurs in performing its technical review, providing such costs are first discussed and agreed by the parties.

The TSO and IP should:

- agree to, and agree to be bound by decisions obtained under, an independent dispute resolution process through which rulings on the interpretation of this Guideline or the adherence to its provisions can be obtained; and
- provide reasonable access to personnel in their respective organisations who are able to knowledgeably discuss the interconnection application and related issues.

The IP should:

- provide the application information specified in the TSO's interconnection policy and any other supporting information as may be reasonably requested by the TSO.

4.2 Initial Application

The IP should provide a completed application form to the TSO, including all information as set out in the TSO's published interconnection process including:

- a) the location of the interconnection point;
- b) designation as a delivery, receipt, or bi-direction point;
- c) proposed ownership demarcation;

- d) desired term for an ICA; and
- e) capacity and pressure requirements and limits.

4.3 Acknowledgement

The TSO should:

- acknowledge the application within five business days of receiving it;
- confirm whether the application is materially complete within 15 business days of receiving it; and
- where further information is requested and supplied, confirm that the application is materially complete within five business days of receiving that additional information.

4.4 Technical Review

Within 25 business days of receiving a materially complete application, the TSO should carry out a review of the application. The review determines the application's technical acceptability and notifies the IP of the results in writing. The technical review should, as a minimum, examine:

- the proximity to an existing interconnection point;
- the feasibility of the pressure limits required;
- any land issues that make the location unacceptable;
- any risk factors that make the location unacceptable; and
- any other aspects of the application that do not comply with the TSO's published requirements for interconnections.

Use of Existing Interconnection Point

Where the requested location for a new interconnection point is close to an existing interconnection point, the TSO may require the new interconnecting party to use the existing interconnection point unless it is unreasonable to do so. In setting this requirement, the TSO should consider:

- land use and terrain between the existing and proposed interconnection point;

- assessed level of risk associated with the new interconnection (for example, where a hot tap is required);
- assessed operational risk associated with the new interconnection;
- capacity of the existing interconnection point;
- cost and scheduled impact of the IP using the existing interconnection point; and
- suitability of the existing station and metering facility.

If the TSO rejects an interconnection application because of proximity to an existing interconnection point, the TSO should provide written justification using the criteria listed above.

The TSO may provide indicative minimum separation distances in its interconnection policy. However, the reasonableness of any requirements should be open to discussion and, if necessary, dispute resolution.

4.5 Acceptance of Application

If the technical review concludes that the application is not acceptable, the TSO should notify the IP in writing, as soon as practicable, of the reasons for this decision. If the IP considers the reasons for rejection to be inadequate, it should initiate the dispute resolution process.

If, on consideration of the findings of the technical review, the TSO considers that there are no material technical objections to establishing the proposed new interconnection point, and the IP's application is otherwise complete, the TSO should notify the IP in writing that its application is accepted. The TSO and IP may then begin the planning phase.

5

Planning Phase

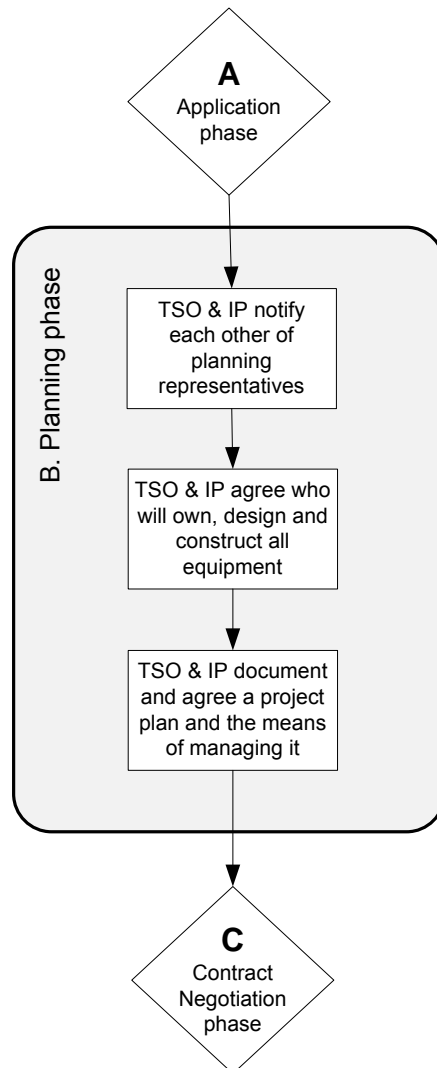

Figure 5 - Planning Phase Process

5.1 Principles

The TSO and IP should:

- provide reasonable access to personnel in their respective organisations who are responsible for agreeing planning matters;
- assign responsibility for the ownership, design and construction of all equipment; and
- develop a project plan and agree how it will be managed.

5.2 Equipment Responsibilities

Ownership

The TSO and IP should agree the ownership and demarcation points of the interconnection equipment. In particular, they need to consider who will own TSO specified assets (noting that regardless of ownership, all TSO specified assets should be designed, constructed, operated, maintained and tested in accordance with the TSO's standards).

The hot tap is directly welded to the transmission pipeline and has a direct effect on the integrity and certification of the pipeline. Consequently, the TSO should have sole discretion in respect of the ownership of the physical connection 'T', and primary isolation valve, including pipe work up to the isolation valve from the transmission pipeline.

For a receipt interconnection point (see Figure 2):

- the equipment will typically comprise pressure control, metering and odorant station⁶, transmission lateral, primary isolation valve, and the connection 'T';
- the TSO should have sole discretion in respect of the ownership of the physical connection 'T', and primary isolation valve, including pipe work up to the isolation valve;
- ownership of the equipment upstream of the primary isolation valve should be agreed between the parties. The TSO is not obliged to own or provide this equipment, and the IP can elect to own this equipment; and
- where there is split ownership, the split should not create small, isolated groups of assets owned by one party within a station owned by the other party, unless agreed by both parties.

⁶ At the TSO's discretion.

For a delivery interconnection point (see Figure 3):

- the TSO should have sole discretion in respect of the ownership of the physical connection 'T', and primary isolation valve, including pipe work up to the isolation valve;
- ownership of the equipment downstream of the primary isolation valve should be agreed between the parties. The TSO should not be obliged to own or provide this equipment. The TSO should give the IP an option to own this equipment permanently, or to transfer ownership to the TSO once constructed; and
- where there is split ownership, the split should not create small, isolated groups of assets owned by one party within a station owned by the other party, unless agreed by both parties.

Design and Construction

Unless otherwise agreed, the party who owns the equipment should also be responsible for its design and construction.

The specifications and arrangements for the design and construction of interconnection equipment that is not owned by the TSO should be set out in an ICEA.

5.3 Project Plan Responsibilities

The TSO and IP should develop a project plan assigning responsibilities for design and construction work between the parties. Generally the party with the greatest design and construction obligations should be responsible for maintaining the project plan, but the project plan governance arrangements should be agreed between the parties.

6

Contract Negotiation Phase

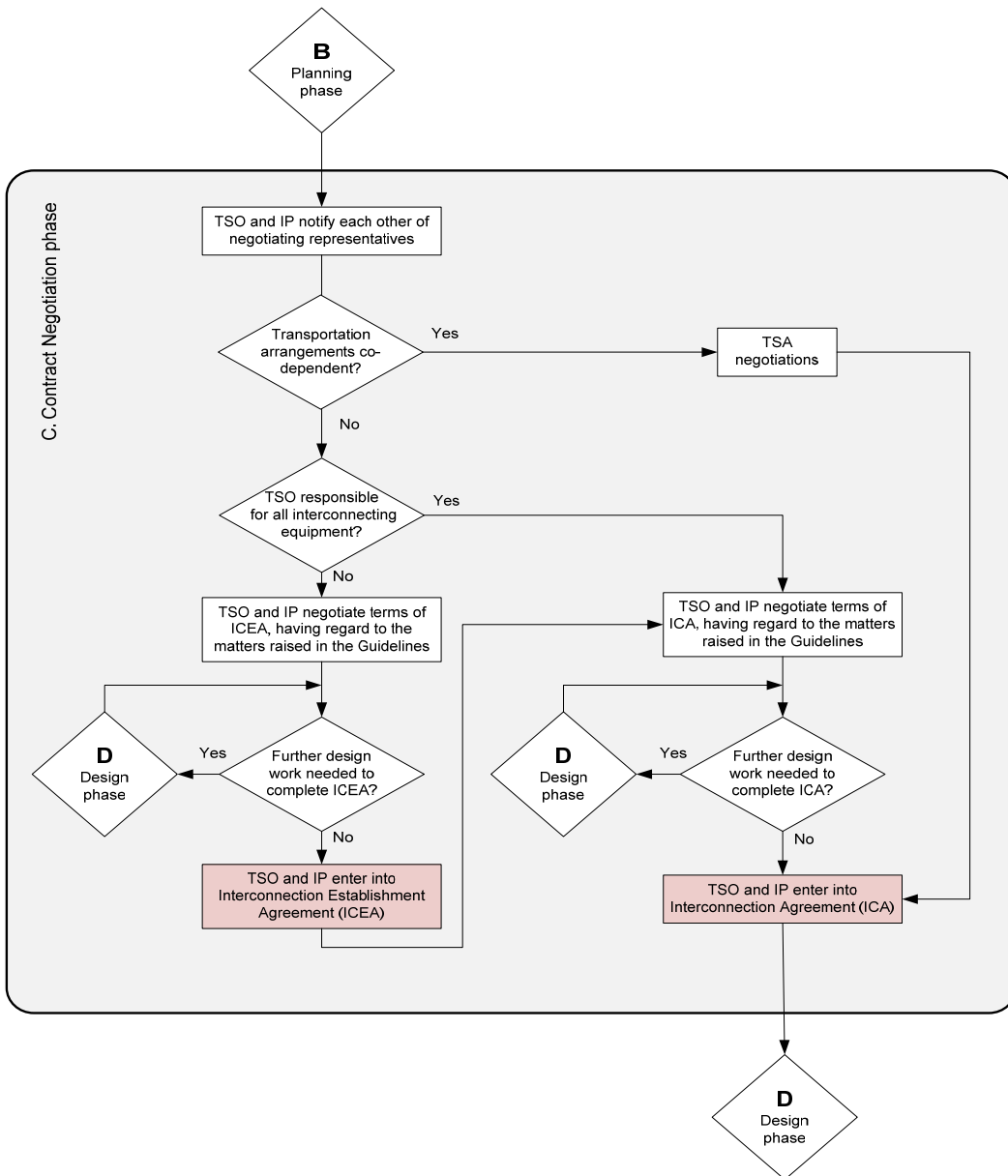

Figure 6 – Contract Negotiation Phase Process

6.1 Principles

The arrangements for the operation of every interconnection point should be set out in writing, preferably in an ICA which should cover, as a minimum, the matters listed in Appendix A. The TSO should publish standard ICAs for receipt and delivery interconnections. Some of the matters are multi-lateral, and best contained in a multi-lateral contract (such as the MPOC), which can form part of the ICA.

In negotiating the ICEA and ICA, the TSO and IP should:

- agree a timetable for negotiation and advise each other of who will take responsibility for the negotiation on behalf of their respective organisations;
- provide reasonable access to personnel who are authorised by the organisation to negotiate an ICEA and/or ICA;
- negotiate in good faith and in a timely manner; and
- meet their own negotiating costs.

The TSO should not be required to accept conditions that would:

- adversely affect the safety or the long-term integrity of the pipeline, or the pipeline's certificate of fitness;
- require it to buy assets without reimbursement;
- reduce the value of its assets, unless it is fully compensated for that loss; or
- require it to incur operating costs, unless it is fully compensated for that cost.

6.2 Sequence of Negotiation

The parties should agree the sequence for contract negotiation and design work, which should be influenced by the proposed ownership arrangements. The ICA negotiation may be conducted in parallel with the ICEA negotiation, following agreement of the ICEA or after completion of the design phase.

In certain circumstances, the TSO may require the ICA and transportation arrangements to be negotiated together. This should not unnecessarily delay establishing an interconnection. The TSO's interconnection policy should discuss those circumstances.

6.3 Interconnection Establishment Agreement (ICEA)

The TSO and IP should determine responsibility for the ownership, design and construction of all interconnection equipment. If the TSO is to be responsible for all aspects of all the equipment, then an ICEA is not required. In other circumstances, the parties need to resolve matters that arise during the design and construction phases in respect of those pieces of equipment that are not solely the TSO's responsibility. If there are only a few items of equipment in this category, a full ICEA may not be warranted and the matters can be covered in the ICA. Otherwise it is recommended the TSO and IP agree an ICEA that covers these aspects of the design and construction phases:

- the scope of work;
- the responsibilities of the parties;
- liabilities and indemnities during construction;
- the timetable;
- consequences and remedies for late delivery;
- cost recovery; and
- arrangements for the transfer of ownership of assets (where the ownership of specific assets is to be assigned to the other party once commissioning of the interconnection station is complete).

There may be matters of design that need to be resolved before an ICEA or ICA can be completed. In that case, progressing the Contract Negotiation phase and Design phase in parallel may be practical.

Standards Applicable to Design, Construction, Commissioning, Testing and Operation

As discussed in section 3.4, the TSO should specify the standards applicable to TSO specified assets. The IP may propose alternative standards that meet or exceed the TSO's standards, and the IP must obtain support of the Certifying Authority, where applicable⁷.

Where non-standard equipment has been, or is likely to be, specified, costs might be incurred. For example, special spare parts may need to be kept, or special test equipment purchased. The parties need to agree who bears these costs.

⁷ Not all matters will be of interest to the CA. For example, the CA will be interested in alternative pipeline design standards, but metering standards are not within its ambit.

Indemnity for New Interconnection Points

In providing a new interconnection, the TSO is exposed to risks associated with constructing the physical interconnection, and at receipt points, the introduction of gas from a new production plant.

The IP should indemnify the TSO for its direct and indirect liability associated with the new interconnection. The indemnity should be limited to a reasonable amount, taking into account loss events that could reasonably be anticipated by a suitably qualified industry expert. The TSO may also require the IP to provide insurance cover to the value of the indemnity. The scope of the indemnity should be:

Receipt interconnection

The IP should indemnify the TSO for losses caused by:

- injection of gas before 'go-live' that does not meet the gas specification;
- injection of gas before 'go-live' that exceeds the maximum allowable operating pressure of the transmission pipeline; and
- failure of hot tap operations, where the IP has accepted responsibility for the hot tap construction work.

Delivery interconnection

The IP should indemnify the TSO for losses caused by:

- failure of hot tap operations, where the IP has accepted responsibility for the hot tap construction work.

The requirement for the IP to indemnify the TSO for these losses should remain in force until the go-live date.

Cost recovery

The parties should agree on a cost recovery mechanism, including provisions for review and early termination. The parties may agree to include cost recovery for the design and construction phases in an ongoing interconnection fee as part of the ICA.

6.4 Interconnection Agreement (ICA)

The following matters should be discussed during ICA negotiations and, where appropriate, covered by the ICA.

Ownership of Assets

The ownership of interconnection assets should be recorded in the ICA. Generally this will be as agreed during the planning phase (section 5.2). However it might be convenient for one party to own an asset through the Construction phase and then to transfer ownership to the other party once commissioning is complete.

Metering

The parties should agree who will own the metering facility. Generally accepted practice is for the IP to own receipt point metering, and the TSO to own delivery point metering.

The metering facility owner should be responsible for ensuring the facility is operated and maintained according to the specified standards and best operating practice. The metering facility owner should provide assurance that the metering facility complies with the specified standards, grant reasonable access to the facilities, and provide maintenance and testing records to the other interconnection party. The interconnection party may choose to install a check metering facility. The ICA should set out the circumstances in which check meter measurements take precedence over the meter specified in the ICA.

An International Accreditation New Zealand (IANZ) accredited laboratory should be used to test meters. The ICA should specify the frequency and cost of testing and error correction procedures. The ICA should provide the ability for the party who does not own the metering facility to require reasonable ad-hoc independent testing, at the cost of the non-owner.

Gas Quality

All gas being transported should comply with the requirements of Gas Specification NZS5442. The MPOC and VTC set out the obligations and liabilities of the parties in respect to gas quality. In addition, the following principles apply in respect of an ICA. (Where there is a contradiction with the relevant provisions of the MPOC or VTC, the provisions of the MPOC or VTC prevail.)

For receipt interconnection points:

- the IP should be responsible for ensuring that the gas meets the requirements of NZS5442 at the interconnection point. The IP should ensure that the design, maintenance, monitoring and testing of

the production facility and gas treatment equipment are compatible with the delivery of gas complying with the requirements of NZS5442 at the interconnection point;

- the IP should provide written reports to the TSO, as reasonably requested, to give assurance of compliance with the gas specification;
- the IP should ensure that the TSO is informed at the earliest practicable time of any event that may adversely affect gas quality, pressure, metering accuracy or safety; and
- the IP should indemnify the TSO for direct losses arising from non-compliance with the gas specification (such direct losses may, for example, arise from internal corrosion).

For delivery interconnection points:

- the TSO should be responsible for advising the IP of any event affecting its ability to supply specification gas, or suspected non-compliance with the gas specification due to contaminants, at the earliest practicable time;
- the TSO should be responsible for ensuring that the specification of transported gas is not materially affected by contamination from compressor oil or pipeline detritus. The delivery interconnection equipment will include filtration to ensure that pipeline borne contaminants are removed to a level that complies with NZS5442; and
- the TSO should indemnify the IP against any direct losses directly attributable to pipeline borne contaminants, except where the filtration and liquid removal equipment is owned by the IP.

Odourisation

The TSO should be responsible for monitoring odourant levels in the transmission system and ensuring delivered gas meets the odourisation standards defined in the Gas Regulations 1993⁸. In the event of non-compliance, the TSO should notify the delivery IP as soon as reasonably practicable.

For receipt interconnection points:

- where the transmission pipeline carries odourised gas, the parties should agree the ownership and location of the odourant injection facility; and

⁸ Soon to be superseded by the Gas Safety Regulations.

- if the IP owns the odorant injection facility, the ICA should record how the IP will provide assurance and reporting to the TSO on the amount of odorant injection.

For delivery interconnection points:

- except in special circumstances⁹, the TSO should be responsible for ensuring that all gas being delivered from the transmission system is odorised according to the odourisation standard; and
- the ICA should record how the TSO will provide assurance and reporting to the IP on the level of odourisation.

Information Transfers

The parties should agree the points of contact and specific requirements for information flow associated with maintenance, emergencies, metering data and day-to-day operations.

Where the interconnection station is connected to the TSO's SCADA system, the data transferred, signal protocols and other design details should be agreed in the ICA.

Pressure Requirements

For receipt interconnection points:

- the TSO should specify, in the ICA, the minimum injection pressures that the IP must deliver at the interconnection point. Generally this pressure will be established by the prevailing pipeline pressure;
- the TSO should specify the Maximum Allowable Injection Pressure (MAIP). The MAIP should not exceed the pipeline Maximum Allowable Operating Pressure (MAOP). Where the pipeline has more than one MAOP, the minimum prevailing MAOP should apply unless the sections of pipeline with the lower MAOP rating are adequately protected; and
- the TSO should not unnecessarily restrict the MAIP.

At delivery interconnection points:

- unless otherwise agreed between the parties, the transmission pipeline pressure should be a minimum of 30 bar, and a maximum of the pipeline's MAOP. The ICA should specify these upper and lower pressure limits;

⁹ For example, direct supply to a power station.

- if the TSO is responsible for the pressure reducing station, the operating pressure range for an associated flow range, and the MAOP of downstream equipment, should be specified in the ICA. The TSO should maintain the pressure control and protection equipment and provide assurance to the IP as reasonably requested or documented in the ICA; and
- the TSO should indemnify the IP for direct losses arising from failure to maintain the pressure below the agreed maximum.

Maintenance and Monitoring

Each party should be responsible for maintaining the equipment it owns. The TSO specified assets should be maintained in accordance with the TSO's standards and specifications, as specified in the ICA. Maintenance and monitoring should also comply with the requirements of the relevant Pipeline Certificate of Compliance.

Emergencies

During emergencies, the TSO should have access to all interconnection equipment and associated sites for the purpose of monitoring and controlling gas flows at interconnection points.

The TSO, acting as a reasonable and prudent operator (RPO), should be able to isolate the gas flow into or out of the transmission pipeline during a declared emergency or contingency event, including (but not limited to):

- the receipt of non-specification gas;
- exceeding the pipeline MAOP; and
- failure to comply with load shedding instructions.

Modifications

Modifications to TSO specified assets should be subject to review and approval of the TSO.

Where modifications materially affect the performance or quality of the interconnection equipment, the modification should be subject to review and approval of the other party.

Termination and Abandonment

The ICA should include the abandonment requirements and responsibilities for the interconnection equipment. Abandonment provisions should comply with AS2885 or other standards as agreed with the TSO.

Site Access

The party responsible for interconnection station security should grant access to the other party, where that other party owns equipment located within the station. Access should be granted for equipment maintenance, monitoring and emergencies, subject to reasonable site safety and access rules and other conditions agreed in the ICA.

7

Design Phase

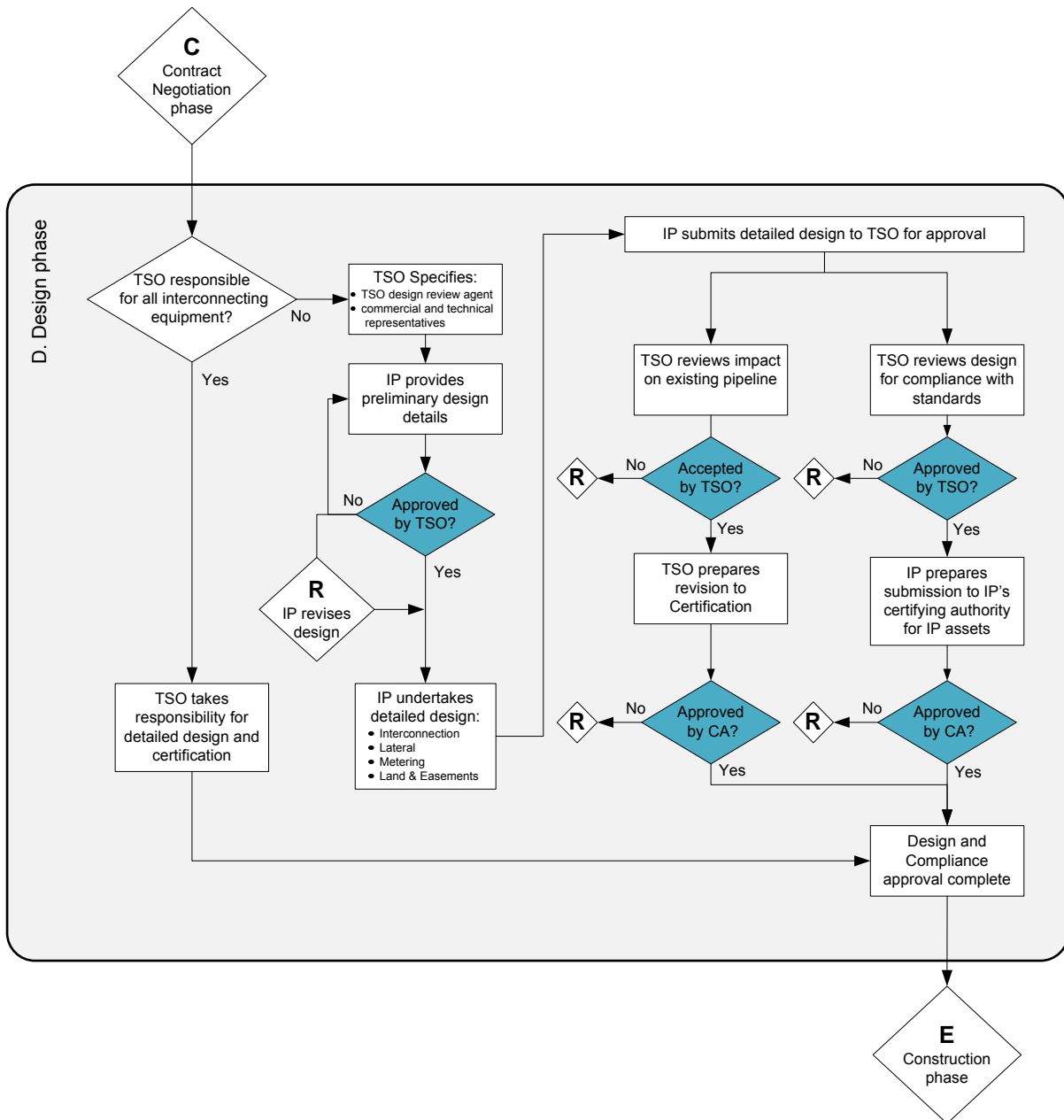

Figure 7 - Design Phase Process

7.1 Principles

The TSO and IP should work cooperatively to develop a design and gather all the information necessary to prepare a revision to the pipeline certificate of fitness.

Unless otherwise agreed:

- each party is responsible for the detailed design and statutory approval of the assets it owns;
- the TSO should also approve the design of the TSO specified assets (see section 3.3); and
- before approving a design, the TSO should consider its effect on the existing transmission pipeline.

7.2 Responsibilities

Where the TSO is responsible for all interconnection equipment, the technical design, and obtaining the necessary certification, should be entirely the responsibility of the TSO. Otherwise the IP should be responsible for part of the design and certification process. In this case the TSO should specify who it will appoint as the design review agent, and who will represent it in commercial and technical discussions with the IP.

The remainder of this section relates to the situation where the IP is responsible for some or all of the design work.

7.3 Preliminary Technical Design

To avoid wasted detailed design effort, the IP should submit a preliminary design to the TSO for approval. The preliminary design should include:

- the design parameters (such as pressure ratings and specifications);
- layout drawings showing the relationship of major items of the plant; and
- broad descriptions of the plant items.

7.4 Detailed Technical Design

Once the preliminary design is approved by the TSO, the IP should complete the detailed design and submit it to the TSO for approval. The detailed technical design should include:

- details of the physical interconnection with the existing pipeline (for example a hot tap);

- new pipeline lateral design;
- new station design (including for example metering, filtration, and SCADA); and
- land access and easement.

The detailed technical design should require considerable interaction and coordinate between the TSO and IP. These Guidelines do not describe these interactions in detail, except to highlight areas where specific approval points occur.

7.5 Effect on Existing Pipeline

The TSO should assess the effect of the new interconnection, considering factors such as the risk to the existing pipeline of over-pressure and internal corrosion, the operability of the system, and any new threats to above-ground assets.

Where the new interconnection introduces unacceptable risks to the existing pipeline (as determined by the TSO or the Certifying Authority), the IP should be informed of the required action to remedy the issue.

Where the interconnection is with an 'authorised' pipeline, the TSO should apply for an amendment to the authorisation.

7.6 Physical Interconnection

The TSO should review and approve the design of the physical interconnection, including the hot tap weld procedure. The TSO should approve the party contracted to perform the interconnection taking into account its experience, qualifications and compliance with the TSO's health and safety rules.

7.7 New Pipeline Lateral

The TSO should review and approve the design of the interconnecting lateral in respect of the cathodic protection on the transmission pipeline and the route (where it is within 50m of the transmission pipeline).

The owner of the lateral should be responsible for obtaining a certificate of fitness for the lateral and associated equipment.

7.8 Station Design

The owner of the station should be responsible for both the design of the station and associated equipment, and for obtaining all necessary statutory approvals.

The station and associated equipment should be designed to meet the operating requirements specified in the ICA.

TSO specified assets should be designed according to the TSO's published standards unless otherwise agreed. The TSO should review and approve the design of the station in respect of the TSO specified assets.

Pressure Control and Protection

For a receipt interconnection point:

- the design should prevent the transmission pipeline from exceeding its pressure limit;
- where the pipeline has more than one MAOP, the minimum prevailing MAOP should apply unless the sections of pipeline with the lower MAOP rating are adequately protected;
- pressure control and protection will typically include:
 - a primary pressure control system (for example a compressor pressure control system);
 - a secondary high-pressure safety system to trip and isolate the gas injection; and
 - a high-pressure alarm; and
- the IP should provide details of the over-pressure protection to the TSO for the purpose of assessing the risk of over-pressurisation in the pipeline certification safety review.

For a delivery interconnection point:

- the design should prevent the downstream pipe work and equipment from exceeding its pressure limit;
- the pressure control and protection should comply with the standards applicable to the downstream pipe work (for example NZS5258 for gas distribution networks); and
- the TSO and owner of the downstream equipment should agree the pressure control and protection scheme.

Metering

Metering design should comply with the TSO's published standards unless otherwise agreed with the TSO. Where metering data is collected via a SCADA system, the data provided should comply with the TSO's published standards.

SCADA

Station data and signals that are to be connected to the SCADA system should be terminated at a signal junction box. Unless otherwise agreed, the TSO should provide the remote telemetry unit. The station design should include provision for housing the remote telemetry unit and provide it with an uninterruptible power supply, as specified in the TSO's published technical standards.

7.9 Land and Easement

The TSO should amend the easement agreements where necessary to allow interconnection of the IP pipeline lateral.

The owner of each station and pipeline lateral should be responsible for securing land ownership or access rights, and for obtaining any resource or building consents.

7.10 Cost Recovery

The cost allocation methodology detailed in the ICEA should provide for the IP to reimburse reasonable costs incurred by the TSO. These include costs to review the detailed design, modify the existing pipeline certificate of fitness, obtain authorisation amendments, and costs associated with land and easement changes.

7.11 Design Approval

The IP should submit for approval design packages for the 'TSO specified assets' that are owned by the IP. To avoid doubt, this includes assets that will be transferred to the TSO upon completion of commissioning.

The IP may provide a single design package or sub-packages, provided that the sub-packages can reasonably be assessed on a stand-alone basis.

The TSO should prepare a report giving either approval, subject to conditions, or rejection including details of design aspects that do not meet the specified standards within 25 business days of receipt of design packages.

Where the design is not approved, the IP should provide additional information or revised design packages to the TSO as appropriate. The TSO should reissue its approval report within 15 days of receiving the complete revised design package.

Each equipment owner is responsible for obtaining approval from the relevant Certifying Authority for its equipment.

7.12 OATIS Design Data

The owner of the station should provide the information, as required by the System Operator, to enable the interconnection point to be mapped into OATIS.

7.13 Disputes

If the TSO does not approve the detailed design, the IP should be notified of the reasons for this decision. If the reason for rejection is disputed, the IP should be able to initiate the dispute resolution process.

8

Construction Phase

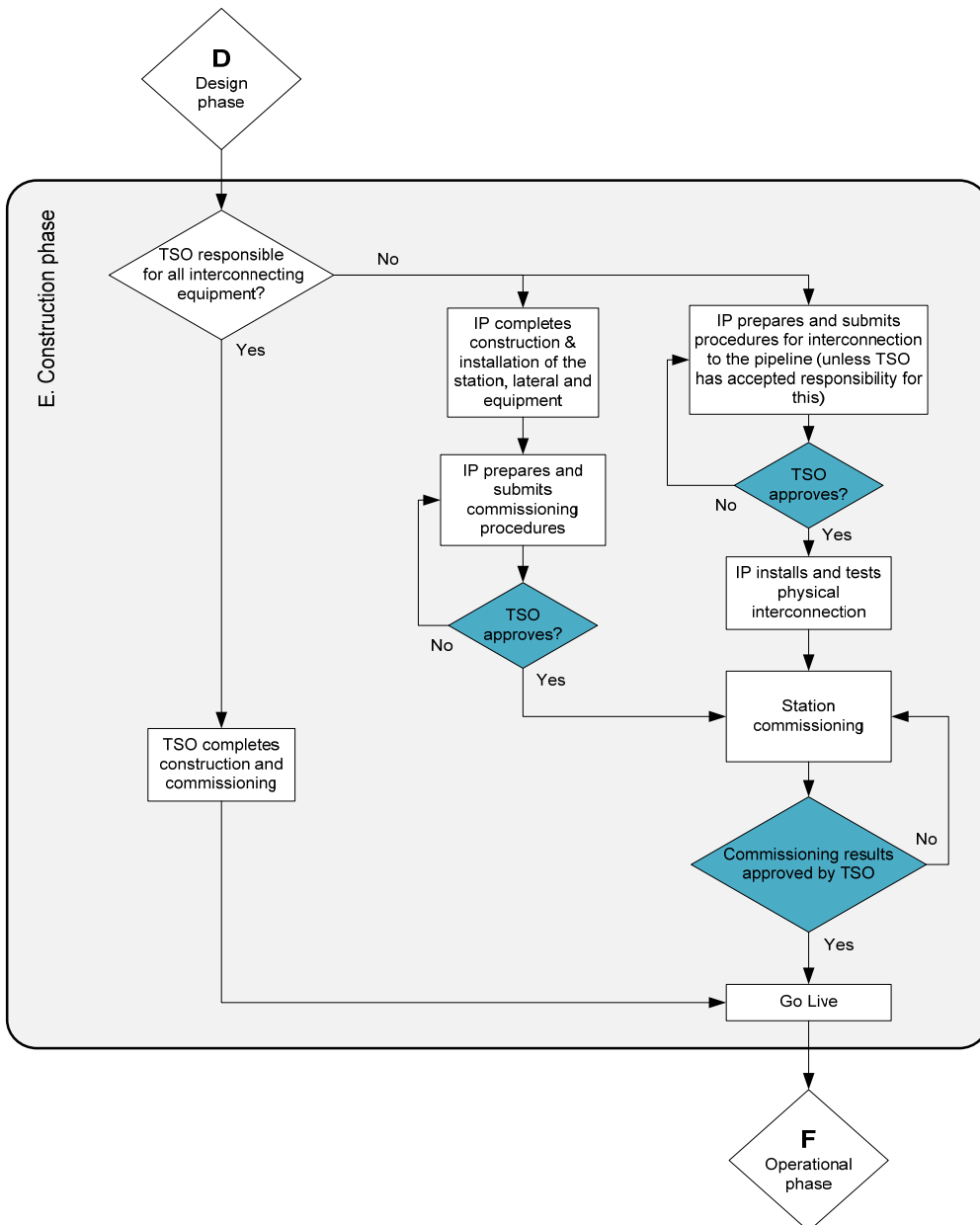

Figure 8 - Construction Phase Process

8.1 Prerequisites to Beginning Construction

Construction of the TSO specified assets may not begin until the Certifying Authority and the TSO have approved the design.

Construction of other equipment should begin once the Certifying Authority has given its approval to the design of that equipment.

Where the IP is responsible for TSO specified assets, the IP should agree with the TSO when the TSO should inspect those assets, and the consequences of the TSO deciding that they do not meet its requirements.

8.2 Transmission Lateral

Where the IP is responsible for constructing the interconnecting transmission lateral, work carried out on the transmission pipeline easement should be, with the approval of the TSO, subject to the TSO's easement arrangements.

The transmission lateral should be cleaned according to recognised pipeline construction standards before the pipeline is put into service. The TSO should have the right to inspect the pipeline cleanliness through, for example, inspection of the cleaning pig runs.

8.3 Hot tap Connection

The IP should provide a hot tap connection procedure and a work plan to the TSO for approval. All work within the pipeline easement will be subject to the TSO's access rules. The TSO will approve the contractor responsible for installing the hot tap. The TSO's Pipeline Manager¹⁰ should have ultimate authority and responsibility for work on the pipeline.

Notice of any hot tap work should be given to the System Operator at least one month before the work starts.

The party responsible for the hot tap should advise the Certifying Authority of the work plan, arrange any consents, and witness tests.

Where the hot tap is installed before the commissioning of other interconnection equipment, a spectacle blind should be installed at the primary isolation valve until the final commissioning is ready to proceed.

¹⁰ As defined in the H&S in Employment Regulations (Pipelines) 1999

8.4 Station Construction

Where the IP is responsible for constructing the interconnection station, it should provide access to the construction site on reasonable notice so that the TSO is able to undertake site construction inspections at agreed hold points for the TSO specified assets.

8.5 SCADA

Where the station is connected to the SCADA system, the IP will co-ordinate with the TSO and facilitate access for the TSO to install and terminate the SCADA remote telemetry unit.

8.6 Testing and Commissioning

Each party should be responsible for the testing, calibration and commissioning of its assets. Testing and calibration will comply with the standards specified by the pipeline certificate of fitness and recognised industry standards. Where the IP owns 'TSO specified assets', the IP will prepare commissioning procedures according to the TSO's standards, and submit these to the TSO for approval.

The primary isolation valve should be controlled by the TSO and will remain closed until the TSO is satisfied that all necessary commissioning tests have been completed and approval has been obtained from the System Operator.

Once the primary isolation valve has been opened, the interconnection equipment is deemed to be live and subject to the requirements of the TSO's permit to work system.

Any gas injected or withdrawn from the pipeline during commissioning should be subject to the requirements of the MPOC or VTC (as applicable) and should be metered.

SCADA Data

All SCADA signals will be tested between the field remote telemetry unit and the TSO's SCADA (or other telemetry system) to the satisfaction and approval of the TSO.

8.7 Final Approval

Following the successful completion of all commissioning and testing to the satisfaction of the TSO and IP, and receipt of all necessary statutory approvals, the TSO will notify the System Operator in writing that the interconnection point is ready for operation.

8.8 Records and Information

The IP will provide the TSO with copies of the certificate of fitness for all interconnection equipment owned by the IP.

Where assets are transferred to the TSO, the IP will supply the TSO with a complete design and quality assurance dossier.

The TSO will provide written approval to the System Operator advising it that the interconnection point is operational. The System Operator will upload the relevant data into OATIS.

Appendix A Documentation

Interconnection Policy

An interconnection policy should include:

Process description:

- a) a description of the process an IP must follow to make a request for a new interconnection service or an enhancement to an existing interconnection service;
- b) an indicative timeframe within which requests are expected to be processed by the TSO, including any interim steps in the request process;
- c) a description of how the TSO will negotiate with the IP to provide part of the requested interconnection service or an alternative interconnection service if the TSO determines that it is unable to provide the requested interconnection service; and
- d) circumstances where the ICA and transportation arrangements shall be negotiated at the same time;

Information:

- e) a full list of the information which an IP must supply with its service application;
- f) a full list of the information that the IP and the TSO are required to provide to each other in the course of the interconnection process and how the TSO will adjust the timeframes where either party is unable to provide that information within the prescribed timeframes;

Pro-forma contracts:

- g) links to standard contracts relevant to interconnection, including:
 - i. Interconnection Establishment Agreement (ICEA); and
 - ii. Interconnection Agreement (ICA);

Relevant policies and standards:

- h) general policies relating to interconnection matters, including:
 - i. the use of existing interconnection points;

- ii. equipment ownership and ownership transfer; and
- iii. other relevant policy matters;
- i) links to other policies and technical standards relevant to interconnection, including:
 - i. pricing policy;
 - ii. list of TSO-specified assets; and
 - iii. technical standards;

Commercial prerequisites:

- j) a description of any commercial requirements that the IP is required to fulfill before acceptance of a request for access, including a description of how the TSO will assess that these requirements have been satisfied, including:
 - i. prudential requirements;
 - ii. bond requirements; and
 - iii. other requirements;

Dispute resolution:

- k) a description of the process for resolving disputes arising out of any negotiation; and

Technical review principles:

- l) a description of the process and principles that will be used to assess the technical acceptability of an interconnection application.

Interconnection Establishment Agreement (ICEA)

An ICEA should include:

Scope of work:

- a) demarcation and responsibility for each party;
- b) agreed contacts and roles;
- c) milestones, approval and hold points;

- d) the principal contractors and their authorised agents;
- e) the Certifying Authority or authorities;
- f) timetable for completing each stage;

Standards and specification:

- g) reference to the TSO's published standards and any other applicable standards and specifications;
- h) any agreed variations from the TSO's published standards;
- i) the Certifying Authority or authorities to be used;

Commercial provisions in respect of the design, construction and commissioning relating to:

- j) insurance;
- k) liabilities and indemnities;
- l) bonds;
- m) guarantees;
- n) cost recovery mechanism;
- o) provisions for transfer of ownership (if any);
- p) payment terms;
- q) co-ordination of contractors services;
- r) access to property;
- s) records; and
- t) dispute resolution process.

The provisions of the ICEA may be incorporated into the ICA.

Interconnection Agreement (ICA)

An ICA should include:

Commercial terms and conditions:

- a) contract period;
- b) prices;
- c) identification of gas custody transfer points;
- d) asset ownership demarcation;
- e) interruptions, emergencies and curtailments;
- f) confidentiality requirements;
- g) force majeure;
- h) liabilities and indemnities;
- i) prudential requirements;
- j) land ownership, easement and access rights;
- k) termination of contract and abandonment;
- l) dispute resolution;
- m) metering standards and testing;

Performance standards and specifications:

- n) maximum injection or delivery rates;
- o) injection or delivery pressure ranges;
- p) gas specification;
- q) standards and specifications for equipment operation, maintenance and testing;
- r) standards and specifications for metering operation, maintenance and testing;
- s) odourisation responsibilities and specifications;
- t) monitoring, reporting and assurance requirements;
- u) access to and control of equipment; and

- v) data transfer requirements, including SCADA.

Technical Standards

Each TSO should publish minimum technical standards for the 'TSO specified assets'. The standards should reflect current best industry practice and should specify the:

- a) design, construction, operating, maintenance and testing requirements;
- b) information required for pipeline certification pursuant to the HSE (Pipeline) Regulations 1999;
- c) hot tap design and installation requirements;
- d) health and safety rules;
- e) excavation safety rules;
- f) cathodic and other corrosion protection requirements;
- g) control and instrumentation requirements;
- h) SCADA signals and interface point;
- i) maximum allowable operating pressure for the transmission pipeline;
- j) hazardous area requirements;
- k) site access, security and signage requirements;
- l) filtration;
- m) pressure control requirements;
- n) levels of redundancy and back-up systems;
- o) temperature lower limits;
- p) qualifications of construction and testing personnel;

For receipt interconnections, the standards should also specify:

- q) filtration and liquid separation requirements;
- r) pressure control and monitoring requirements;
- s) over pressure protection system requirements; and

- t) odourisation facility design and monitoring requirements.

Metering Standards

Each TSO should publish minimum technical standards for metering facilities at interconnection points. The metering standards should reflect current best industry practice and should specify the:

- a) design, installation, operating, maintenance and testing standards;
- b) levels of redundancy and back-up systems;
- c) requirements for protection from contaminants;
- d) protection from excess flow rates (if applicable);
- e) flow range criteria for single or dual metering tubes;
- f) criteria for flow validation (series operating configuration);
- g) requirements for automatic meter range changeover;
- h) acceptable types/models of meter;
- i) requirements for gas analysis (gas chromatograph);
- j) gas chromatograph measurements and frequency of measurement;
- k) SCADA signals and interface point;
- l) standards for calculating compressibility;
- m) procedures for correcting faulty or missing metering data; and
- n) testing and calibration requirements.